

ATMOZ 2-75

VACUUM PACKAGING MACHINE



Optional without extra costs: 2 seal bars (left-right)

FEATURES

- Standard with 2 seal bars (front-back): 2 x 660 mm
- Optional without extra costs: 2 seal bars (left-right)
- Standard double seal (two wires). Optional without extra costs: Cut-off or Wide seal (10 mm)
- Silicone holders easily removable for cleaning and maintenance purposes
- Pump capacity: 160 m³/h Busch vacuum pump
- Pump maintenance and cleaning program
- Machine cycle: 15-40 sec
- Standard Digital control with 10 program memory and Time control
- Flat work plate
- Comes with 1 layer of insert plates for a faster cycle and product adjustment
- Stainless steel exterior

OPTIONS

- 1-2 Cut-off seal
- Sensor control
- Liquid control
- Gas flush (incl. pressed air connection)
- Soft Air to protect the product and vacuum bag
- ACS

ACCESSORIES

- Inclined insert plate
- 2nd layer of insert plates
- Service kit for standard maintenance

DESCRIPTION

The robust, stainless steel Atmoz 2-75 vacuum packaging machine has a specific construction of both the lid and the work plate. This results in longer seal bars compared to other series. This double chamber floor model is standard equipped with a Busch vacuum pump and complies with CE standards.



Henkelman offers standard 1 year warranty on the Atmoz-series.

SEAL BAR CONFIGURATION

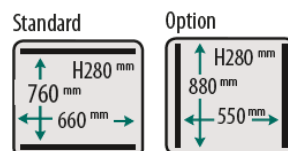

VACUUM PACAGKING MACHINE ATMOZ 2-75 – SPECS

VACUUM PACKAGING MACHINE ATMOZ 2-75 – SPEC SHEET

DIMENSIONS

In mm

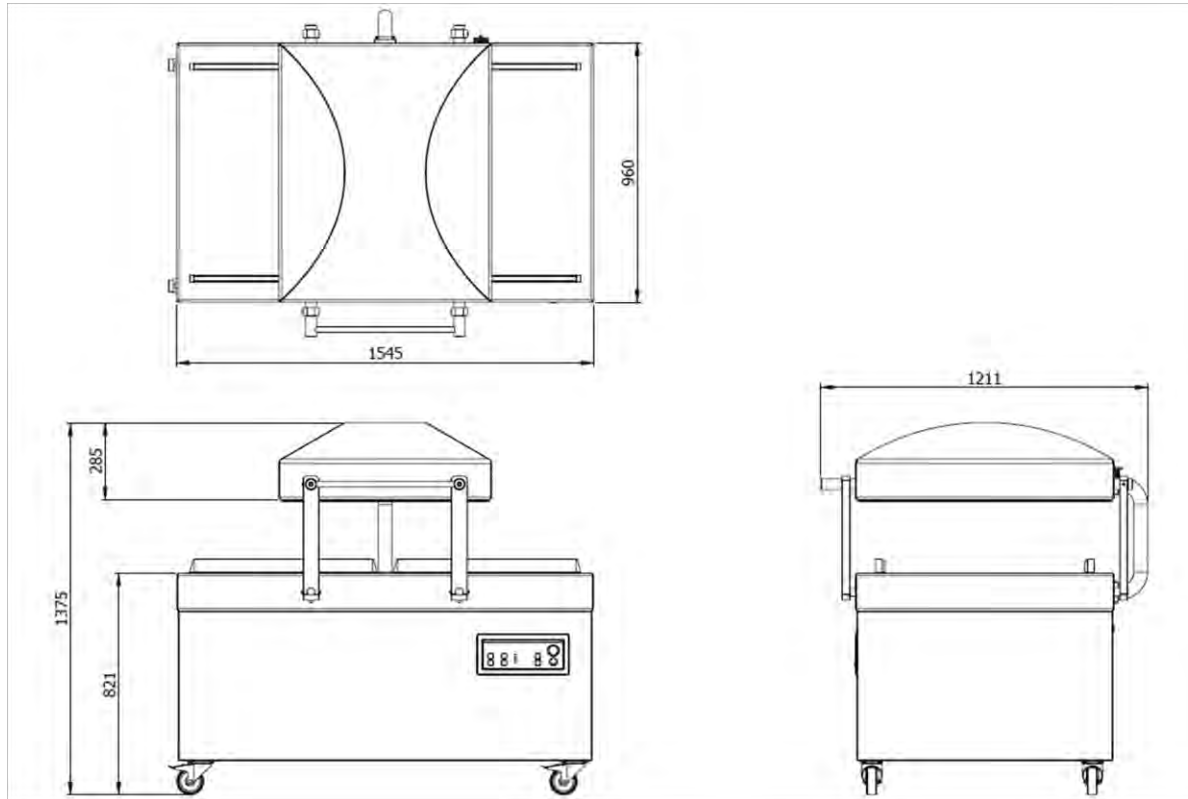

Model	Dimensions (mm)		Voltage* (Hz)	Pump capacity (m ³ /h)	Power (kW)	Weight (kg)
	Chamber (usable space) L x W x H	Machine L x W x H				
Atmoz 2-75	760 x 660 x 280	1211 x 1545 x 1106	400V-3-50	160	2,2 – 4,8	462

* Other voltages available



HENKELMAN BV
Titaniumlaan 10
5221 CK 's-Hertogenbosch
The Netherlands

Sales support
P +31 73 621 36 71
E info@henkelman.com
Service/technical support
P +31 73 621 36 71
E service@henkelman.com